

# Panasonic®



Omnivision VHS

## Video Cassette Recorder Operating Instructions (Basic Operations)

For advanced operations, see the separate  
“Advanced Operations” instruction book.

### Model No. PV-V464S

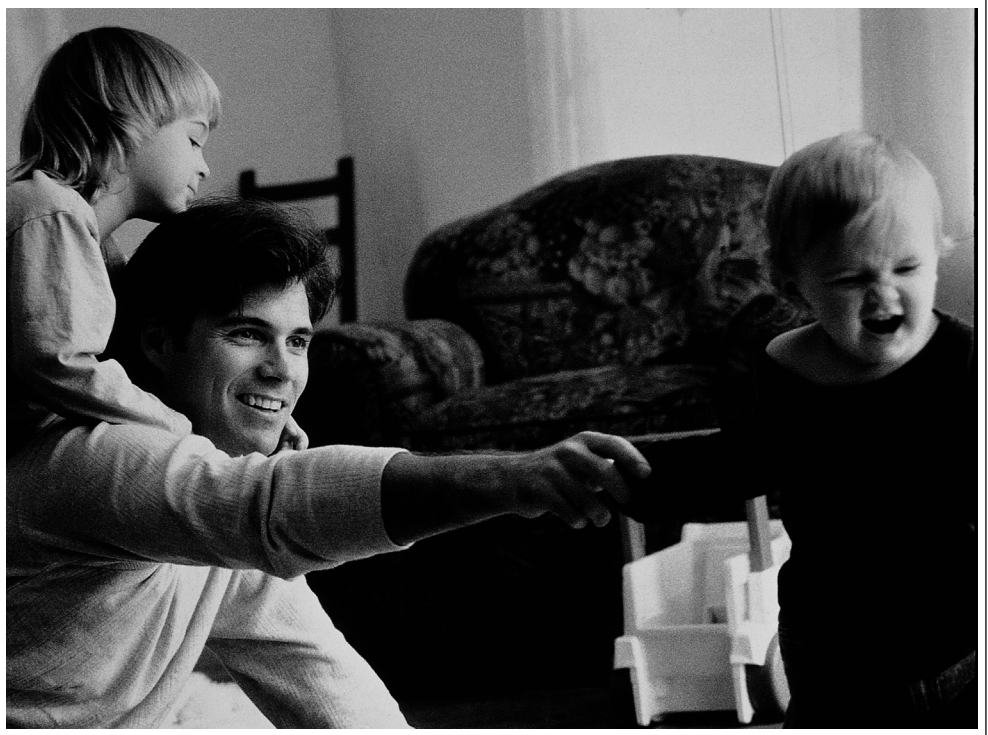

### Table of Contents

Important Safeguards and Precautions .....	2
Before Using .....	3
Connections and Initial Setup (Ready to Play) .....	4
Playback / Record on a Tape .....	5
Timer Recording .....	6
Location of Controls .....	7, 8
Reset All VCR Memory Functions .....	8
Spanish (Español) Quick Use Guide .....	9, 10, 11
Limited Warranty / Customer Services Directory .....	12



As an ENERGY STAR® Partner, Matsushita Electric Corporation of America has determined that this product or product model meets the ENERGY STAR® guidelines for energy efficiency.

Please read these instructions carefully before attempting to connect, operate or adjust this product. Please save this manual. Spanish Quick Use Guide is included.  
(Guía para rápida consulta en español está incluida.)

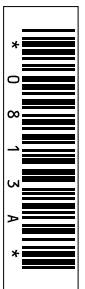

LSQT0813 A

# Important Safeguards and Precautions

## ⚠ WARNING

TO REDUCE THE RISK OF ELECTRIC SHOCK, FIRE, INJURY TO PERSONS OR DAMAGE TO THIS PRODUCT, READ AND RETAIN ALL SAFETY AND OPERATING INSTRUCTIONS. HEED ALL WARNINGS IN THE MANUAL AND ON THE PRODUCT.

### INSTALLATION

#### 1 POWER SOURCE CAUTION

Operate only from a power source indicated on the unit or in this manual. If necessary, have your Electric Utility Service Company or Video Products Dealer verify the power source in your home.

#### 2 POLARIZED OR GROUNDING PLUG

As a safety feature, this Video product comes with either a polarized power cord plug (one blade is wider than the other), or a three-wire grounding type plug.

#### POLARIZED PLUG CAUTION:

This plug will only fit into an outlet one way. If you cannot fully insert the plug, try reversing it. If it still will not fit, have an electrician install the proper wall outlet. Do not defeat the safety feature by tampering with the plug.

#### GROUNDING PLUG CAUTION:

This plug will only fit into a three-hole grounding outlet. If necessary, have an electrician install the proper outlet. Do not defeat the safety feature by tampering with the plug.

#### 3 POWER CORD

Make sure power cords are routed so that they are not likely to have anything rest on them, roll over them, or be in the way of walking traffic. If an extension cord is used, make sure it also has either a polarized or grounded plug and that the cords can be securely connected. Frayed cords, damaged plugs, and damaged or cracked wire insulation are hazardous and should be replaced by a qualified service technician. Overloaded outlets and extension cords are fire hazards and should be avoided.

#### 4 DO NOT BLOCK VENTILATION HOLES

Ventilation openings in the cabinet release heat generated during operation. If they are blocked, heat build-up inside the unit can cause failures that may result in a fire hazard or heat damage to cassettes. For protection, follow these rules:

- Never cover ventilation slots or the unit while in use, or operate the unit when placed on a bed, sofa, rug, or other soft surface.
- Avoid built-in installation, such as a book case or rack, unless proper ventilation is provided.

#### 5 AVOID EXTREMELY HOT LOCATIONS OR SUDDEN TEMPERATURE CHANGES

Do not place the unit over or near any kind of heater or radiator, in direct sunlight, inside a closed vehicle, etc.. Do not move the unit suddenly between areas of extreme temperature variation. If the unit is suddenly moved from a cold place to a warm place, moisture may condense in the unit and on the tape.

#### 6 TO AVOID PERSONAL INJURY

- Do not place unsecured equipment on a sloping surface.
- Do not place this unit on any support that is not firm, level, and adequately strong. The unit could fall causing serious injury to a child or adult and damage to the unit.
- An appliance and cart combination should be moved with care. Quick stops, excessive force, and uneven surfaces may cause the appliance and cart combination to overturn.
- Carefully follow all operating instructions and use the manufacturer's recommended accessories when operating this unit or connecting it to any other equipment.



### OUTDOOR ANTENNA INSTALLATION

#### 1 SAFE ANTENNA AND CABLE CONNECTION

If an outside antenna or cable system is connected to the equipment, be sure the antenna or cable system is grounded so as to provide some protection against built up static charges and voltage surges.

Section 810 of the National Electrical Code, ANSI/NFPA 70 (in Canada, part 1 of the Canadian Electrical Code) provides information with respect to proper grounding of the mast and supporting structure, grounding of the lead-in wire to an antenna discharge unit, size of grounding conductors, location of antenna discharge unit, connection to grounding electrodes and requirements for the grounding electrode.

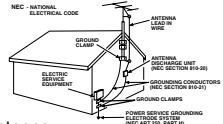

#### 2 KEEP ANTENNA CLEAR OF HIGH VOLTAGE POWER LINES OR CIRCUITS

An outside antenna system should be located well away from power lines, electric light or power circuits and where it will never come into contact with these power sources if it should happen to fall. When installing an outside antenna, extreme care should be taken to avoid touching power lines, circuits or other power sources as this could be fatal. Because of the hazards involved, antenna installation should be left to a professional.

### USING THE VIDEO UNIT

If the unit has been in storage or moved to a new location, refer first to the INSTALLATION section of these safeguards.

#### 1 KEEP THIS VIDEO UNIT AWAY FROM WATER OR MOISTURE OF ANY KIND.

2 **IF EQUIPMENT IS EXPOSED TO RAIN, MOISTURE, OR STRONG IMPACT**, unplug the unit and have it inspected by a qualified service technician before use.

#### 3 DURING AN ELECTRICAL STORM

During a lightning storm, whether indoors or outdoors, or before leaving the unit unused for extended periods of time, disconnect all equipment from the power source as well as the antenna and cable system.

#### 4 WHEN THE UNIT IS PLUGGED IN

- Never expose the unit to rain or water. DO NOT OPERATE if liquid has been spilled into the unit. Immediately unplug the unit, and have it inspected by a service technician. Fire and shock hazards can result from electrical shorts caused by liquid contact inside.
- Never drop or push any object through openings in the unit. Some internal parts carry hazardous voltages and contact can cause electric shock or fire hazard.
- Avoid placing the unit directly above or below your TV set as this may cause electrical interference. Keep all magnets away from electronic equipment.

#### 5 USING ACCESSORIES

Use only accessories recommended by the manufacturer to avoid risk of fire, shock, or other hazards.

#### 6 CLEANING THE UNIT

Unplug the unit. Then, use a clean, dry, chemically untreated cloth to gently remove dust or debris. DO NOT USE cleaning fluids, aerosols, or forced air that could over-spray, or seep into the unit and cause electrical shock. Any substance such as wax, adhesive tape, etc. may mar the cabinet surface. Exposure to greasy, humid, or dusty areas may adversely affect internal parts.

### SERVICE

#### 1 DO NOT SERVICE THIS PRODUCT YOURSELF

If, after carefully following the detailed operating instructions, this Video product does not operate properly, do not attempt to open or remove covers, or make any adjustments not described in the manual. Unplug the unit and contact a qualified service technician.

#### 2 IF REPLACEMENT PARTS ARE REQUIRED

Make sure the service technician uses only parts specified by the manufacturer, or those having the same safety characteristics as the original parts. The use of unauthorized substitutes may result in fire, electric shock, or other hazards.

#### 3 HAVE THE SERVICE TECHNICIAN PERFORM A SAFETY CHECK

After any service or repairs to the unit, request the service technician to conduct a thorough safety check as described in the manufacturer's service literature to ensure that the video unit is in safe operating condition.

# Safety Precautions/Mesures de sécurité

## ⚠ WARNING

To prevent fire or shock hazard, do not expose this equipment to rain or moisture.

## ⚠ CAUTION

To prevent electric shock, match wide blade of plug to wide slot, fully insert.

AVERTISSEMENT : Afin de prévenir tout risque d'incendie ou de chocs électriques, ne pas exposer cet appareil à la pluie ou à une humidité excessive.

ATTENTION : Pour éviter les chocs électriques, introduire la lame la plus large de la fiche dans la borne correspondante de la prise et pousser jusqu'au fond.

FCC WARNING : Any unauthorized changes or modifications to this equipment would void the user's authority to operate.



This symbol warns the user that uninsulated voltage within the unit may have sufficient magnitude to cause electric shock. Therefore, it is dangerous to make any kind of contact with any inside part of this unit.

This symbol alerts the user that important literature concerning the operation and maintenance of this unit has been included. Therefore, it should be read carefully in order to avoid any problems.

# Before Using

## Congratulations

on your new purchase! With proper use, this dependable product will provide years of enjoyment. Please fill in the information below. (Serial number is on tag on back of VCR.)

- Date of Purchase \_\_\_\_\_
- Dealer Purchased From \_\_\_\_\_
- Dealer Address \_\_\_\_\_
- Dealer Phone No. \_\_\_\_\_
- Model No. **PV-V464S** \_\_\_\_\_
- Serial No. \_\_\_\_\_

## Accessories

Remote Control  
EUR7723KA0

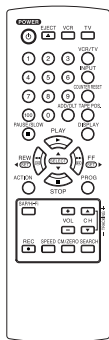

Batteries 2 "AA"



RF Coaxial Cable  
LSJA0418



To order accessories, call toll free  
1-800-332-5368.

## Loading the Batteries

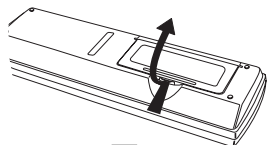

1) Open cover.

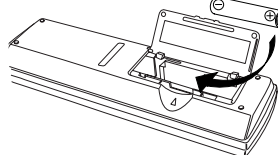

2) Insert batteries as marked.

3) Close cover.

**Battery replacement caution**

- Do not mix old and new batteries.
- Do not mix alkaline with manganese batteries.

## Prevent Accidental Tape Erasure

Break off the tab to prevent recording.

To record again

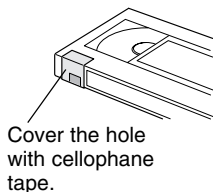
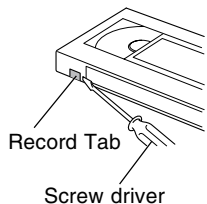

## Record/Playback Time

Only use tapes with the **VHS** mark in this unit.

Tape Speed Setting	Type of Video Cassette		
	T120	T160	T180
SP (Standard Play)	2 Hours	2 Hours 40 Minutes	3 Hours
SLP (Super Long Play)	6 Hours	8 Hours	9 Hours

## Head Cleaning

Old or damaged tapes may clog heads.

### Video Head Clog Sensor

Screen-right appears during play if clogging is detected. To remove screen, press PLAY.

VIDEO HEADS MAY  
NEED CLEANING  
PLEASE INSERT HEAD  
CLEANING CASSETTE  
OR REFER TO MANUAL  
END :PLAY

- Use "dry" type head cleaning cassette only. (Part No. NV-TCL30PT is recommended.)
- Follow cleaning tape instructions carefully. Excessive use of tape can shorten head life.

## Built-in Head Cleaner

A clean video head helps produce a clear picture. So, we have equipped your VCR with a built-in, non-chemical head cleaning system that helps prevent clogging of the video heads. Cleaning is performed each time you load or unload a video cassette.

- This feature is preventative only. If your video heads are seriously clogged, consider the use of a chemical non-abrasive head cleaning kit or contact your nearest servicenter by visiting our Web Site (p.12).

## Cleaning the VCR

Use soft, dry cloth or dusting attachment of a vacuum to remove dust from all cabinet vent holes. You may moisten cloth with non-abrasive, antistatic cleaner/ polisher.

### Caution:

Alcohol and various solvents could damage finish.

## Specifications

**Power Source:** 120 V AC, 60 Hz

**Power Consumption:** Power On  
Approx. 18 W  
Power Off  
Approx. 0.95 W

**Video Signal:** EIA Standard NTSC color

**Video Recording System:** 4 rotary heads helical scanning system

**Audio Track:** 1 track (Normal)  
2 channel (Hi-Fi Audio Sound)

### Tuner

**Broadcast Channels:** VHF 2 ~ 13, UHF 14 ~ 69

**CABLE Channels:** Midband A ~ I (14 ~ 22)  
Superband J ~ W (23 ~ 36)  
Hyperband AA ~ EEE (37 ~ 64)  
Lowband A-5 ~ A-1 (95 ~ 99)  
Special CABLE channel 5A (01)  
Ultraband 65 ~ 94, 100 ~ 125

### Operating Temperature:

5 °C ~ 40 °C (41 °F ~ 104 °F)

**Operating Humidity:** 10 % ~ 75 %

**Weight:** 2.55 kg (5.6 lbs).

**Dimensions:** 430 (W) x 98 (H) x 240 (D) mm  
16-15/16" (W) x 3-7/8" (H) x 9-7/16" (D) inch

Note: Designs and specifications are subject to change without notice.

## Features for a Quality Picture

### Digital Auto Picture

Automatically controls the video output signal for less noise depending on the tape condition.

### Digital Auto Tracking

Continuously analyzes the signal and adjusts for optimum picture quality.

### Manual Tracking Control (to reduce picture noise)

Use during Playback and Slow Motion mode to reduce picture noise.

Press CH (TRACKING) ▲/▼ on the remote control or on the VCR until the picture clears up. To return to Auto Tracking, press POWER off, then on again a few seconds later.



### V-Lock Control (to reduce picture jitter)

In Still mode, CH (TRACKING) ▲/▼ operate as a V-Lock control.

# Connections / Initial Setup (Ready to Play)

**Make all cable or antenna connections before plugging into an AC outlet.**  
 Plugging the VCR Power Cord into an AC wall outlet starts auto channel and clock set.

## Connecting (Select a method)

### For ANT./Cable → VCR → TV

- 1 Connect cable from Antenna/Cable to VCR's IN FROM ANT. jack.
- 2 Connect VCR's OUT TO TV jack to TV's ANT. IN jack with included RF Cable.

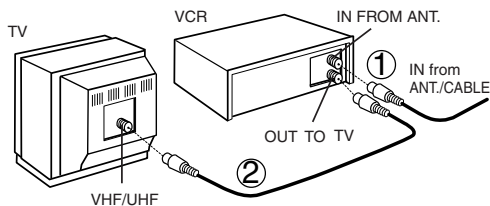

### For DSS/Cable Box → VCR → TV

- 1 Connect your cable box's OUT jack to the VCR's IN FROM ANT. jack with an RF cable.
- 2 Connect VCR's OUT TO TV jack to TV's ANT. IN jack with included RF Cable.

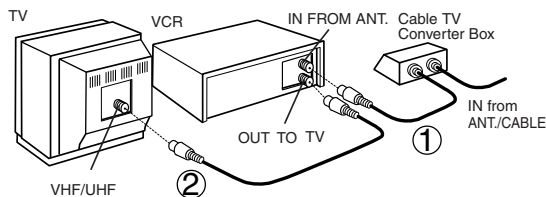

## CAUTION

Over tightening "Nut type" RF coaxial cables may damage jacks. Finger tighten only.

## Initial Setup (Ready to Play)

- 1 Turn TV on and tune to channel 3.
- 2 Plug VCR Power Cord into AC wall outlet. VCR comes on and auto channel and clock set starts.

- If screen below does not appear... check all connections. Try tuning TV to channel 4.
- To change VCR's output channel, see "VCR's Output Channel" (p. 12) in Advanced Operations book.

Plug VCR Power plug into an AC wall outlet.

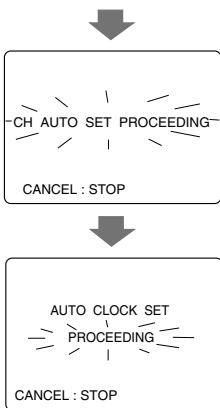

If you use a cable box, turn it on and set it to the Public Broadcasting Station (PBS) channel in your time zone. If you use a DSS receiver, it must be turned off.

## Notes

- Function buttons are void during Initial Setup.
- To eject a tape during Auto Set, press EJECT on remote or STOP twice on VCR. Then make settings manually. (See Advanced Operations book, p. 12.)
- If Auto Clock Set takes more than 30 minutes, press STOP and perform settings manually. (See Advanced Operations book, p. 12.)

- 3 Settings are made automatically. When complete, this screen appears.

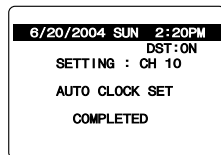

If "AUTO CLOCK SET IS INCOMPLETE" appears, manually set clock (below).

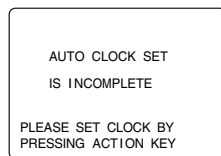

## Manual Clock Set

If Auto Clock Set was incomplete.

- 1 Press ACTION\* on remote to display CLOCK menu.

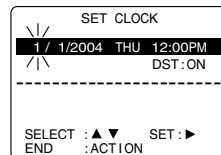

- 2 Press ▲ ▼ to select the month and ► to set. In the same manner, select and set the date, year, time, and DST (Daylight Saving Time).

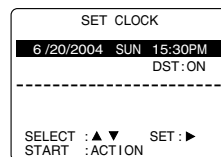

- 3 Press ACTION to start clock and exit.

# Playback / Record on a Tape

## Playback a Tape

### 1 Insert a tape.

- Loose or peeling labels may cause tape jam.
- VCR power comes on. "VCR" lights on Multi Function Display. If Auto VCR/TV (see p. 10 of Advanced Operations book) is set to "OFF," press VCR/TV until "VCR" lights on the Multi Function Display.

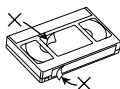

### 2 Press PLAY to play tape.

- If tape has no rec. tab (p. 3), auto play begins.

#### Special Features During Play

#### ■ Forward/Reverse Scene Search

- ➔ Press FF or REW.
- ➔ Press PLAY to release.

After search has begun, each additional press of FF or REW changes speed.

#### Notes

- Picture interruption may occur with some TVs.
- FF and REW search speed may vary depending on current tape position.
- After 10 minutes in search mode, VCR returns to Play mode to protect the tape and the video heads.

#### ■ Still (Freeze) Picture

- ➔ Press PAUSE/SLOW.
- ➔ Press PLAY to release.

#### ■ Slow Motion Picture

- ➔ Hold down PAUSE/SLOW in Still mode.
- ➔ Press PLAY to release.

#### Notes

- These features work best in SP or SLP mode.
- The sound will be muted.
- To reduce picture noise, see "Manual Tracking Control" on p. 3.
- After 3 minutes in Still or Slow mode, VCR stops to protect the tape and the video heads.

### 3 Press STOP to stop tape.

#### Rapid Rewind/FF

#### ■ Press REW or FF in Stop mode to rewind or fast forward tape.

- Rewinds a T-120 tape in approx. 1 minute.

#### ■ Press EJECT on remote,

or STOP/EJECT on VCR to eject tape.

## Record on a Tape

### 1 Insert a tape with a record tab (p. 3).

- VCR power comes on. "VCR" lights on Multi Function Display. If Auto VCR/TV (see p. 10 of Advanced Operations book) is set to "OFF," press VCR/TV until "VCR" lights on the Multi Function Display.

### 2 Press CH ▲▼ or NUMBER keys

- to select the channel.
- If channel number is over 100, first press 100 key then the other 2 digits.
- For "LINE" input, see p. 9 of "Advanced Operations" book.

### 3 Press SPEED to set record speed (p. 3).

- SP = Standard Play
- SLP = Super Long Play

### 4 Press REC to start recording.

- To edit, press PAUSE/SLOW to pause, and again to resume recording.

### 5 Press STOP to stop recording.

#### ■ One Touch Recording

(recording in progress)

Press REC repeatedly to set length as follows:

- 30 min. ➔ 1 hr. ➔ 1:30 ➔ 2:00 ➔ 3:00
- ➔ 4:00 ➔ exit.

The VCR shuts off at the length set.

#### ■ Record one station, watch another

Press VCR/TV

- ("VCR" goes out on Multi Function Display),
- ➔ select channels on TV (recording continues).

#### ■ Select channels on VCR

Press VCR/TV in Stop or Pause mode.

- ("VCR" lights on Multi Function Display),
- ➔ select channels on VCR.

#### Notes

- Watching one channel and recording another is not possible when using Cable Box or DSS Receiver.
- After 5 minutes in Pause mode, VCR stops to protect the tape and the video heads.

This video recorder, equipped with HQ (High Quality) system, is compatible with existing VHS equipment. Only use tapes with the **VHS** mark. Only tapes tested and inspected for use in 2, 4, 6, and 8 hour machines are recommended.

## Auto Operation Functions

#### ■ Auto Play

Insert a tape ➔ Power comes on ➔ Play starts if there is no record tab (see p. 3).

#### ■ Auto Rewind

Play  
Fast Forward } ➔ Tape end ➔ Rewind ➔ Stop

#### ■ Play Auto Eject

(Repeat Play must be off)

Play ➔ Tape end ➔ Rewind ➔ Stop ➔ Tape ejects if there is no record tab

**\*Important:** If a remote control button does not work when pressed, press the VCR button on the remote and try the button again.

# Timer Recording

## Timer Recording

**1** Press **PROG\*** to display program screen.

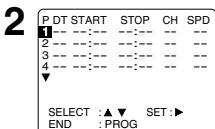

**1) Press ►.**  
**2) Set record DATE,** press ▲▼ to select:  
 1~31= one time,  
 or DAILY= Monday~Friday,  
 or WEEKLY= same time  
 each week (see right).

### Example

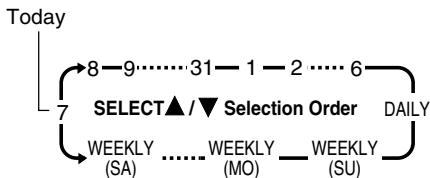

**3) Set remaining items,** press ► to set START/ STOP times, CH (channel) or LINE input (p. 9 of Advanced Operations book), and tape speed (p. 3). Then press ▲▼ to select.

Press **PROG** to end programming.

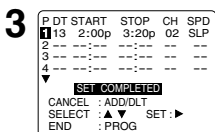

### To Enter More Programs

Press ▲▼ to select and press ► to set an unused program. Then repeat step 2. Or, press **PROG** to exit.

**4** Press **POWER** off to set the timer recording. ("TIMER" lights on Multi Function Display.)

## Review, Replace, or Clear Program

(Recording is not in progress)

**a** Press **PROG** to display program screen.

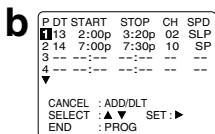

Press ▲▼ to select desired program.

### c To Replace program...

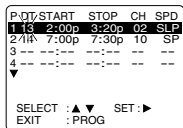

**1) Press ►** to display.  
**2) Repeat Step 2** (above) to set new programs.

or

### To Clear program...

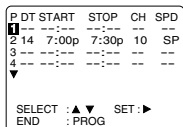

Press **ADD/HLT**.

**d** Press **PROG** to end the programming.

## Cancel a Timer Recording

(Recording is in progress)

Press **POWER** and then **STOP** within 10 seconds to cancel the Timer Recording.

(The **TIMER** indicator goes on on Multi Function Display.)

## Notes

- If you are using a Cable Box, VCR Timer Programming Channel (Step 2 above) must be set to the Cable Box output channel and your Cable Box must be manually set to the desired channel. The Cable Box must be left on.
- If a power interruption occurs while programming the timer, the timer program(s) may be canceled. If "TIMER PROGRAMS WERE LOST DUE TO POWER INTERRUPTION" appears on-screen, please re-enter the timer programs.

### Important notes when using DSS receiver

- When recording programs via DSS receiver, DSS receiver must be left on.
- When recording programs via an antenna or cable, DSS receiver must be turned off.

# Location of Controls

## Remote Control Buttons

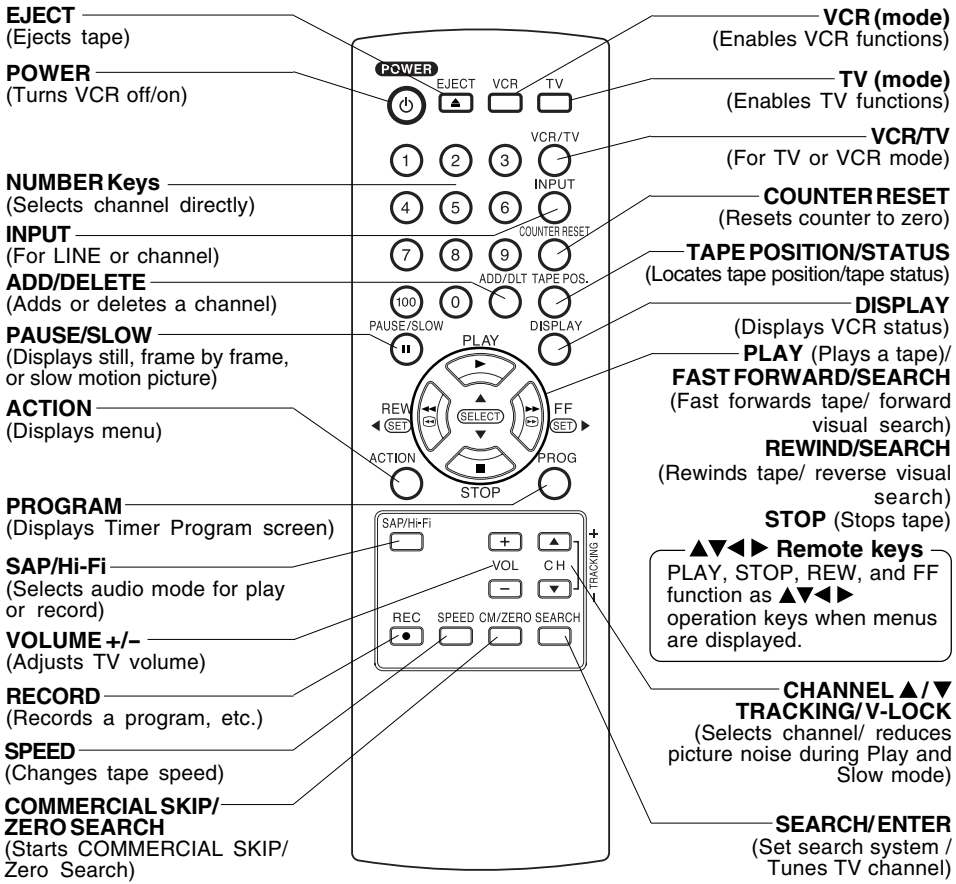

## Remote Control

**EJECT button:** Press to eject tape. EJECT is not available during recording.

## Front View of the VCR

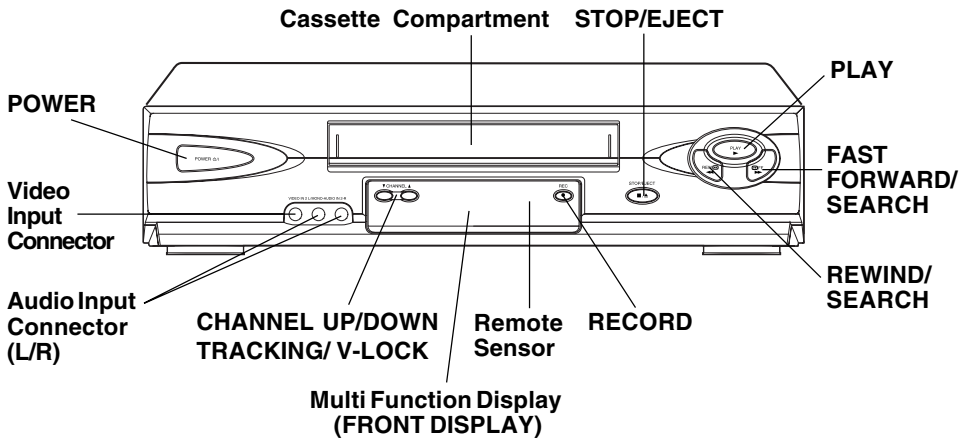

**\*Important:** If a remote control button does not work when pressed, press the VCR button on the remote and try the button again.

# Location of Controls/ Reset All VCR Memory Functions

## Multi Function Display (FRONT DISPLAY)

**Power Indicator**  
Lights up when power is on.

**Timer Indicator**  
Lights up when the VCR is set for a Timer Recording, or when One Touch Recording (OTR) is used.  
Flashes when a Timer Recording is set, but a tape has not been inserted into the VCR.



**VCR Indicator**  
Lights up when the VCR/TV selector is set to VCR.

**Clock/ Status/ Channel/ Speed Display**  
Displays current time. Briefly displays VCR status when you press a function button, channel number or "L1" or "L2" when you select channel or line input, and recording speed when you press SPEED.

**Hi-Fi Indicator**  
Lights up when Hi-Fi audio is present in Playback Mode.

## Rear View of the VCR

**AC Power Plug**  
While plugged into an AC outlet, the VCR consumes 0.95 W of electrical power in off condition.

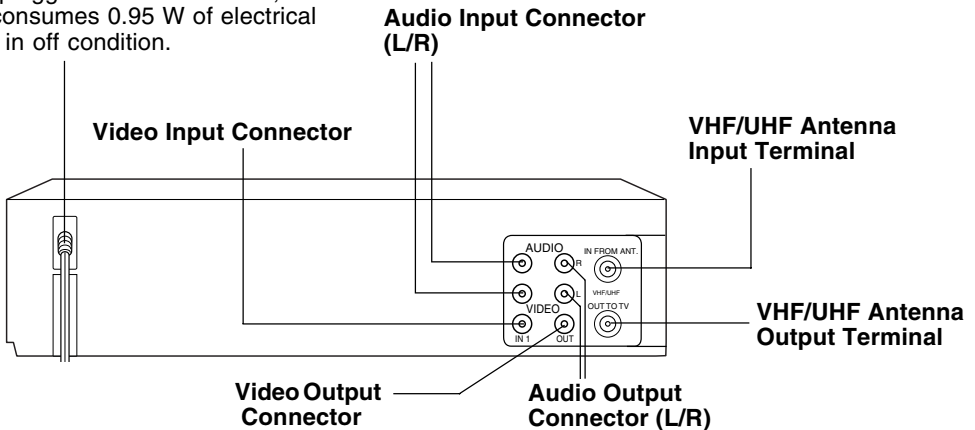

## Reset All VCR Memory Functions

Returns to factory setting. Use if relocating VCR, or if Initial Setup needs to be redone.  
• Make sure a tape is not inserted in the VCR.

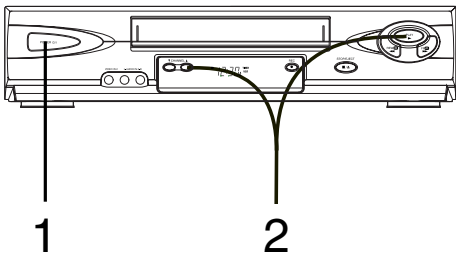

- 1 Turn VCR Power on.
- 2 Press and hold both **PLAY** and **CHANNEL ▲** on the VCR for more than 5 seconds.  
• The power shuts off.
- 3 Perform "Initial Setup (Ready to Play)" on page 4.

## Note to CABLE system installer

This reminder is provided to call the CABLE system installer's attention to Article 820-40 of the NEC in USA (and to the Canadian Electrical Code in Canada) that provides guidelines for proper grounding and, in particular, specifies that the cable ground shall be connected to the grounding system of the building, as close to the point of cable entry as practical.

Panasonic Consumer Electronics Company,  
Division of Matsushita Electric Corporation of America  
One Panasonic Way Secaucus, New Jersey 07094



Panasonic Sales Company ("PSC"),  
Division of Matsushita Electric of Puerto Rico, Inc.  
Ave. 65 de Infantería. Km. 9.5 San Gabriel Industrial Park, Carolina,  
Puerto Rico 00985

Printed in Indonesia  
LSQT0813 A  
S1203-1014



# Spanish Quick Use Guide/ Guía para rápida consulta

## CONEXIONES/CONFIGURACIÓN INICIAL (READY TO PLAY)

Realice la conexión de la antena o TV por cable antes de enchufar el cable de CA. La videograbadora iniciará automáticamente la fijación de los canales y del reloj al enchufar el cable de CA.

### CONEXIONES

#### Para Ant/Cable → VCR → TV

- 1 Conecte el cable de la antena al terminal IN FROM ANT del VCR.
- 2 Conecte el terminal OUT TO TV del VCR a la entrada de la antena VHF/UHF del TV con el cable RF incluido.

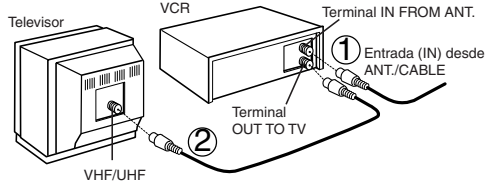

#### Para Sistema Digital de Satellite (DSS)/ Convertidor de cable → VCR → TV

- 1 Conecte la salida de convertidor de cable al terminal IN FROM ANT.
- 2 Conecte el terminal OUT TO TV del VCR a la entrada de la antena VHF/UHF del TV con el cable RF incluido.

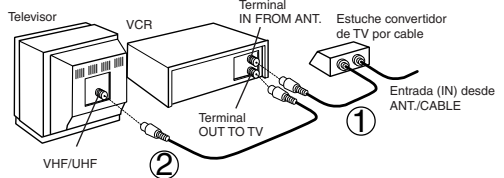

### CONFIGURACIÓN INICIAL

- 1 Encienda el TV y cambie al canal 3.
- 2 Enchufe el cable de CA. La videograbadora se encenderá e iniciará las fijaciones de los canales y del reloj.

- Si la pantalla a continuación no aparece... verifique todas las conexiones. Intente sintonizar el TV en el canal 4.
- Para cambiar el canal de salida del VCR, consulte las instrucciones de "VCR's Output Channel (Canal de salida del VCR)" en la página 12 de las operaciones avanzadas.

#### Enchufe el cable de CA.

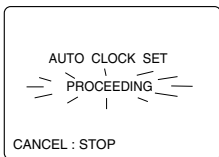
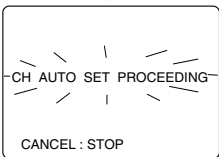

Al inicio, el idioma de la pantalla está fijado a inglés. Para cambiar el idioma, seleccione la pantalla MENU (para su ayuda vea la página 12 de las operaciones avanzadas.)

Si está usando un convertidor de TV por cable y en su area hay un canal de Public Broadcast Station (PBS), ajuste su convertidor al canal PBS de su area.

Si está usando un receptor DSS, este debe estar apagado.

#### Nota

- Los botones de funciones no funcionan durante la configuración inicial.
- Para retirar un cassette durante el ajuste automático, presione EJECT en el control remoto o STOP dos veces en el aparato. En este caso, los ajustes de los canales y la hora se deben hacer manualmente. Para los ajustes seleccione la pantalla MENU. (Vea la p.12 de Libro de Operaciones Avanzadas).
- Dependiendo de las condiciones, el ajuste automático puede durar más de 30 minutos. En ese caso, presione STOP para detener el ajuste automático y realice los ajustes manualmente en la pantalla MENU. (Vea la p.12 de Libro de Operaciones Avanzadas).

### PRECAUCIÓN

Al usar cables coaxiales RF del tipo "tuercas", apriételes solamente con los dedos. Un apriete excesivo puede dañar los terminales.

- 3 Las fijaciones se realizan automáticamente. Cuando termina las fijaciones, aparecerá la siguiente pantalla.

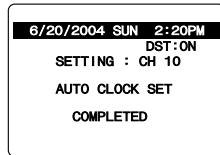

Si aparece en la pantalla "AUTO CLOCK SET IS INCOMPLETE (FIJACION AUTOMATICA DEL RELOJ ES INCOMPLETO)", Ajuste el reloj como se describe a continuación.

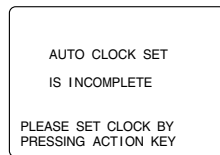

### AJUSTE MANUAL DEL RELOJ

Si la fijación ha sido incompleta.

- 1 Presione la tecla ACTION en el control remoto para visualizar la pantalla del menú CLOCK.

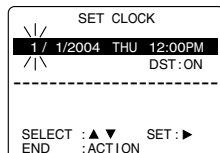

- 2 Presione ▲ ▼ para seleccionar el mes y ▶ para ajustar. De la misma forma, seleccione y ajuste la fecha, año, hora y DST (Hora de Verano).

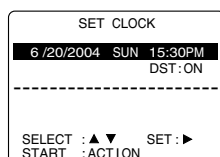

- 3 Presione dos veces la tecla ACTION para poner el RELOJ en marcha y salir.

## OPERACIONES BÁSICAS PARA LA REPRODUCCIÓN

- 1 Inserte una cassette.
- 2 Presione **PLAY** para reproducir el cassette.
  - La alimentación del VCR se activa. Si Auto VCR/TV (vea la p.10 de Libro de Operaciones Avanzadas) está en "ACT", presione VCR/TV en el control remoto para el modo VCR.
  - Si el cassette no tiene la lengüeta de prevención de grabación (p. 3), se inicia la reproducción automáticamente.

### Detalles especiales durante la grabación

- Presione **FF** o **REW** para búsqueda de escenas hacia delante/ hacia atrás. Presione **PLAY** para liberar. Después de comenzar la búsqueda, cada vez que presione **FF** o **REW** cambiará la velocidad.
- Presione **PAUSE/SLOW** para imagen Fija (Congelada). Presione **PLAY** para liberar.
- Mantenga pulsado **PAUSE/SLOW** en el modo de imagen fija para imágenes en cámara lenta. Presione **PLAY** para liberar.

- 3 Presione **STOP** para detener el cassette.

### Rebobinado/Avance rápido

- Presione **REW** o **FF** en el modo de parada para rebobinado/avance rápido del cassette.
  - Rebobina una cinta T-120 en aproximadamente 1 minuto.
- Presione **EJECT** en el control remoto, o **STOP/EJECT** en el VCR para expulsar el cassette.

## OPERACIONES BÁSICAS PARA LA GRABACIÓN

- 1 Inserte el cassette con lengüeta de protección de grabación (p. 3).
  - La alimentación del VCR se activa. Si Auto VCR/TV (vea la p.10 de Libro de Operaciones Avanzadas) está en "ACT", presione VCR/TV en el control remoto para el modo VCR.
- 2 Presione **CH** ▲▼, o las teclas de números para seleccionar el canal.
- 3 Presione **SPEED** para seleccionar la velocidad de grabación (p. 3).
  - SP = Reproducción normal.
  - SLP = Reproducción extra larga.
- 4 Presione **REC** para comenzar a grabar.
  - Para eliminar escenas indeseadas, presione **PAUSE/SLOW** para hacer una pausa, y al presionar nuevamente continua la grabación.
- 5 Presione **STOP** para detener la grabación.

- **Grabación de un toque.** Presione **REC** repetidamente para ajustar la duración de la grabación como sigue: como sigue: 30 min. → 1 hr → 1:30hr → 2:00 → 3:00 → 4:00 → Salida. La VCR se apagará automáticamente en un intervalo seleccionado de tiempo.
- **Ver un canal y grabar otro.** Presione **VCR/TV**. (La indicación VCR se apagará en la "visualización de Multi-Función") → Seleccione canales de TV (Mientras permanece grabando)
- **Seleccione los canales en el VCR.** Presione **VCR/TV** en el modo de parada o pausa. (la indicación "VCR" se encenderá en la visualización multi-función) → Seleccione canales en su VCR.

## PROGRAMACIÓN FÁCIL PARA LA GRABACIÓN CON TEMPORIZADOR

- 1 Presione **PROG** para visualizar la pantalla de Programación.
- 2 1) Presione ► para ajustar.  
2) Para ajustar la **FECHA** de grabación, presione ▲▼ para seleccionar:

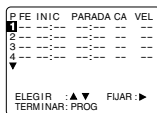

1-31 = una vez, o  
DIARIO = a la misma hora de lunes a viernes, o SEMANA = a la misma hora cada semana.

### Orden para elegir

#### Ejemplo

Fecha de hoy — 7 — 8-9-...-31- 1-2-...-6 — DIARIO  
 SEMANAL (SA) ..... SEMANAL (LU) ..... SEMANAL (DO)

- 3) Ajustes los ítems restantes, presione ► para ajustar los tiempos de INICIO/PARADA, CANAL o entrada de LINEA (página 9 de las operaciones avanzadas), y la velocidad de la cinta (página 3). Luego presione ▲▼ para seleccionar.

Presione **PROG** para finalizar el programa.

- 3 Presione ▲▼ para seleccionar un número que no está usando para ingresar mas programas y presione ► para ajustar. Luego repita el paso 2.

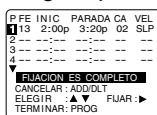

Presione nuevamente **PROG** para salir.

- 4 Presione **POWER off** para ajustar el temporizador. (Se ilumina "TIMER" en el panel delantero)

## REVISIÓN, REEMPLAZO O BORRADO DE PROGRAMACIONES (no se puede efectuar durante la grabación)

- a Presione **PROG** para visualizar la pantalla de Programación.

- b Presione ▲▼ para seleccionar programa deseado.

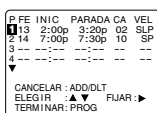

- c Para reemplazar programa...

- 1) Presione ► para desplegar menu.
- 2) Repita paso 2 (ver arriba) para introducir el nuevo programa.



o

Para cancelar programas...

Presione **ADD/HLT**

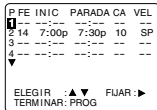

- d Presione **PROG** Para terminar programacion.

## PARA CANCELAR LA GRABACIÓN CON TEMPORIZADOR (la grabación está teniendo lugar)

Presione **POWER** y luego **STOP** dentro de los 10 segundos para cancelar la grabación con temporizador (el indicador **TIMER** se apagará en la Pantalla de Multi-Función)

## Medidas de seguridad y precauciones importantes

### ⚠️ ADVERTENCIA

**PARA REDUCIR EL RIESGO DE GOLPES ELÉCTRICOS, INCENDIOS, HERIDAS O DAÑOS A ESTE PRODUCTO, LEA Y GUARDE TODAS LAS INSTRUCCIONES DE SEGURIDAD Y FUNCIONAMIENTO. TENGA EN CUENTA TODAS LAS ADVERTENCIAS INDICADAS EN EL MANUAL Y EN EL PRODUCTO.**

#### INSTALACIÓN

- 1 PRECAUCIÓN CON LA FUENTE DE ALIMENTACIÓN**  
El equipo solo debe hacerse funcionar desde una fuente de alimentación que se indique en la unidad o en este manual. Si fuera necesario, haga revisar la fuente de alimentación de su hogar por parte de la Compañía de Suministro Eléctrico o por parte de su Distribuidor de Productos de Vídeo.
- 2 CONECTOR POLARIZADO O CON TOMA A TIERRA**  
Como característica de seguridad, este producto de vídeo viene equipado con un enchufe de cable de alimentación polarizado (solo una pata es más ancha que la otra), o con un enchufe del tipo con toma a tierra de tres patas.

#### PRECAUCIÓN CON EL ENCHUFE POLARIZADO

Este enchufe sólo entrará en la toma en un sentido. Si no pudiera introducir el enchufe a fondo, intente darle la vuelta. Si aún así no entrara, llame a un técnico electricista para que le instale una toma de red adecuada. No desactive esta función de seguridad manipulando el enchufe de ninguna manera.

#### PRECAUCIÓN CON ENCHUFES CON TOMA A TIERRA

Este enchufe sólo entrará en una toma con conexión a tierra de tres orificios.

Si fuera necesario, que un técnico electricista le instale la toma de red adecuada. No desactive esta función de seguridad manipulando el enchufe de ninguna manera.

#### 3 CABLE DE ALIMENTACIÓN

Asegúrese de que los cables de alimentación son dispuestos de tal forma que no se apoye nada sobre ellos, no ruede nada sobre ellos, o que estén en el paso de tráfico al caminar. Si se utilizara un cable alargador, asegúrese de que también disponga de un enchufe polarizado o con toma a tierra y de que puede conectarse firmemente. Los cables pelados, los enchufes averiados o hilos quebrados constituyen un peligro y deben ser reemplazados por un técnico cualificado del servicio técnico. Las tomas eléctricas de la red general sobrecargadas y los cables de extensión constituyen riesgos de incendio y han de evitarse en lo posible.

#### 4 NO BLOQUEE LOS ORIFICIOS DE VENTILACIÓN

Las aberturas de ventilación del mueble liberan el calor generado durante el funcionamiento de la unidad. Si se bloquearan, el calor acumulado dentro de la unidad podría ocasionar fallos que pueden llevar a riesgos de incendio o daños por calor en las cassettes utilizadas.

#### 5 EVITE UBICACIONES MUY CALIENTES O SOMETIDA A CAMBIOS BRUSCOS DE TEMPERATURA

No coloque la unidad encima o cerca de cualquier tipo de calefactor o regulador, bajo la luz solar directa, dentro de vehículos, etc...

No traslade la unidad súbitamente entre sitios con variaciones extremas de temperatura. Si la unidad es llevada bruscamente de un sitio frío a otro cálido, la humedad puede condensarse en la unidad y en la cinta.

#### 6 PARA EVITAR LESIONES PERSONALES

- No coloque equipos no fijados en superficies inclinadas.
- No coloque esta unidad sobre ningún soporte que no esté firme, nivelado y que sea adecuadamente fuerte. La unidad podría caerse y producir graves lesiones a niños o adultos y dañarse la unidad misma.
- La combinación de aparato y carrito debe moverse con cuidado. Las paradas súbitas, una fuerza excesiva ya las superficies irregulares pueden ocasionar el vuelco de la combinación de aparato y carrito.
- Siga atentamente las instrucciones de funcionamiento y utilice los accesorios recomendados por el fabricante al hacer funcionar esta unidad o al conectarla a otros equipos.



#### INSTALACIÓN DE LA ANTENA EXTERIOR

- 1 CONEXIÓN SEGURA DE LA ANTENA Y DE LOS CABLES**  
Si se conectara una antena exterior o sistema de cable conectado al equipo, el usuario deberá asegurarse de que la antena o el sistema de cable disponen de toma a tierra como forma de proporcionar protección contra la acumulación de cargas estáticas y saltos de corrientes. La sección 810 del Código Eléctrico Nacional, ANSI/NFPA 70 (en Canadá, la parte 1 del Código Eléctrico Canadiense) proporciona información con respecto a la conexión a tierra correcta del mástil y la estructura de soporte, conexión a tierra de los cables de bajada de antena a una unidad de descarga, tamaño de los conductores a tierra, ubicación de la unidad de descarga de antena, conexión de los electrodos a tierra y requisitos del electrodo de toma a tierra.

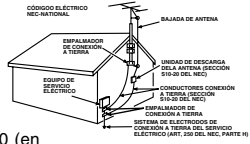

#### 2 MANTENGA LA ANTENA LIBRE DE LÍNEAS O CIRCUITOS DE ALTO VOLTAJE

Un sistema de antena exterior deberá ser colocado bien alejado de líneas de alimentación, luz eléctrica o circuitos de alimentación para que nunca esté en contacto con tales fuentes de alimentación si se cayera. Al instalar una antena exterior, debe tenerse muchísimo cuidado para evitar las líneas de alimentación, circuitos u otras fuentes de alimentación ya que esto podría resultar mortal. Debido a los riesgos implicados en la instalación de una antena, tal operación debe dejarse a un profesional.

#### UTILIZACIÓN DE LA UNIDAD DE VÍDEO

Si la unidad ha estado almacenada o es trasladada a una nueva ubicación, remítase primero a la sección de INSTALACIÓN de estas medidas de seguridad.

#### 1 MANTENGA ESTÁ UNIDAD DE VÍDEO ALEJADA DEL AGUA O DE HUMEDAD DE CUALQUIER TIPO

Si el equipo es expuesto a la lluvia, humedad, o fuertes impactos, desenchufe la unidad y que sea revisada por un técnico cualificado antes de volver a utilizarla.

#### 3 DURANTE UNA TORMENTA ELÉCTRICA

Durante una tormenta con rayos, tanto en interiores como en el exterior, o antes de dejar la unidad sin utilizar durante largos períodos de tiempo, desconecte todos los equipos de la fuente de alimentación así como la antena y el sistema de cableado.

#### 4 AL ENCHUFAR LA UNIDAD

- No exponga nunca la unidad a la lluvia o el agua. NO LA HAGA FUNCIONAR si se ha derramado líquido dentro de la unidad. Desenchufe la unidad inmediatamente ya que sea revisada por un técnico. Pueden producirse incendios o sacudidas eléctricas derivadas de cortocircuitos eléctricos causados por el contacto de líquidos con el interior de la unidad.
- No deje caer ni introduzca ningún objeto por las aberturas de la unidad. Algunas piezas internas tienen un voltaje peligroso y el contacto con ellas puede producir sacudidas eléctricas o incendios.
- Evite colocar la unidad directamente encima o debajo del televisor, ya que esto podría causar interferencias eléctricas. Mantenga cualquier tipo de imán alejados de equipos electrónicos.

#### 5 UTILIZACIÓN DE ACCESORIOS

Utilice sólo accesorios recomendados por el fabricante para así evitar riesgos de incendio, sacudidas eléctricas y otros peligros.

#### 6 LIMPIEZA DE LA UNIDAD

Desenchufe la unidad. Luego utilice un paño limpio y seco, sin tratamiento químico para quitar suavemente el polvo o suciedad. NO UTILICE productos de limpieza, aerosoles, o aire comprimido que pudieran causar un exceso de pulverización o introducirse en la unidad y ocasionar sacudidas eléctricas. Cualquier substancia, como cera, cinta adhesiva, etc., podría arruinar el acabado de la superficie. La exposición a substancias grasosas, áreas húmedas o polvorientas puede afectar de manera adversa a las piezas internas.

#### SERVICIO

#### 1 EL USUARIO NO DEBE REALIZAR NINGUNA OPERACIÓN DE SERVICIO TÉCNICO POR SÍ MISMO

Si, después de observar atentamente las detalladas instrucciones de funcionamiento, este producto de vídeo no funcionara correctamente, no intente abrir o extraer las tapas, o realizar cualquier ajuste no indicado en este manual. Desenchufe la unidad y llévela a un técnico cualificado de servicio técnico.

#### 2 SI FUERAN NECESARIAS PIEZAS DE RECAMBIO

Asegúrese de que el técnico de servicio utiliza sólo piezas especificadas por el fabricante, o de las mismas características que las piezas originales. La utilización de subsitutos no autorizados puede ser causa de incendios, sacudidas eléctricas, u otros peligros.

#### 3 QUE EL TÉCNICO DE SERVICIO TÉCNICO REALICE UNA COMPROBACIÓN DE SEGURIDAD

Después de cualquier servicio o reparación de la unidad, solicite al técnico de servicio que realice una completa comprobación de seguridad tal como se describe en la literatura de servicio técnico del fabricante para asegurarse así que la unidad de vídeo se encuentra en condiciones de funcionamiento seguras.

## PRECAUCIONES DE SEGURIDAD

### ⚠️ ADVERTENCIA

**PARA PREVENIR INCENDIOS O CHOQUES ELÉCTRICOS NO EXPONGA ESTE APARATO A LA LLUVIA O LA HUMEDAD.**

### ⚠️ PRECAUCIÓN

**PARA PREVENIR CHOQUES ELÉCTRICOS, ASEGURASE QUE LA CLAVIJA HAGA JUEGO CON EL ENCHUFE Y CONÉCTELO COMPLETAMENTE.**



Este símbolo advierte al usuario de que hay voltaje sin aislamiento dentro de la unidad de suficiente magnitud como para ocasionar sacudidas eléctricas. Por lo tanto, resultará peligroso realizar cualquier tipo de contacto con toda pieza interna de la unidad.

Este símbolo alerta al usuario de que se ha incluido importante literatura sobre el funcionamiento y mantenimiento de esta unidad. Por tanto, debe leerse atentamente tal literatura a fin de evitar cualquier problema.

# Limited Warranty

**PANASONIC CONSUMER ELECTRONICS COMPANY,  
DIVISION OF MATSUSHITA ELECTRIC  
CORPORATION OF AMERICA**

One Panasonic Way  
Secaucus, New Jersey 07094

**PANASONIC SALES COMPANY,  
DIVISION OF MATSUSHITA  
ELECTRIC OF PUERTO RICO, INC.,**

Ave. 65 de Infantería, Km. 9.5  
San Gabriel Industrial Park,  
Carolina, Puerto Rico 00985

## Panasonic VHS VCR Products

### Limited Warranty

#### Limited Warranty Coverage

If your product does not work properly because of a defect in materials or workmanship, Panasonic Consumer Electronics Company or Panasonic Sales Company (collectively referred to as "the warrantor") will, for the length of the period indicated on the chart below, which starts with the date of original purchase ("warranty period"), at its option either (a) repair your product with new or refurbished parts, or (b) replace it with a new or a refurbished product. The decision to repair or replace will be made by the warrantor.

Product or Part Name	Parts	Labor
All components of VCR except item listed below	One (1) Year	Ninety (90) Days
Video Tape (in exchange for defective video tape)	Five (5) Days	Not Applicable

During the "Labor" warranty period there will be no charge for labor. During the "Parts" warranty period, there will be no charge for parts. You must mail-in your product during the warranty period.

If non-rechargeable batteries are included, they are not warranted.  
This warranty only applies to products purchased and serviced in the United States or Puerto Rico.  
This warranty is extended only to the original purchaser of a new product which was not sold "as is".

#### Mail-In Service

For assistance in the continental U.S.A. in obtaining repairs please ship the product to:

**Panasonic Services Company  
Customer Servicenter Suite B  
4900 George McVay Drive  
McAllen, TX 78503**

For assistance in Puerto Rico call Panasonic Sales Company  
(787) 750-4300 or fax (787)768-2910

When shipping the unit carefully pack and send it prepaid, adequately insured and preferably in the original carton. Include a letter detailing the complaint and provide a day time phone number where you can be reached.

**IF REPAIR IS NEEDED DURING THE WARRANTY PERIOD THE PURCHASER WILL BE REQUIRED TO FURNISH A SALES RECEIPT/PROOF OF PURCHASE INDICATING DATE OF PURCHASE, AMOUNT PAID AND PLACE OF PURCHASE. CUSTOMER WILL BE CHARGED FOR THE REPAIR OF ANY UNIT RECEIVED WITHOUT SUCH PROOF OF PURCHASE.**

#### Limited Warranty Limits And Exclusions

This warranty ONLY COVERS failures due to defects in materials or workmanship, and DOES NOT COVER normal wear and tear or cosmetic damage. The warranty ALSO DOES NOT COVER damages which occurred in shipment, or failures which are caused by products not supplied by the warrantor, or failures which result from accidents, misuse, abuse, neglect, mishandling, misapplication, alteration, faulty installation, set-up adjustments, misadjustment of consumer controls, improper maintenance, power line surge, lightning damage, modification, introduction of sand, humidity or liquids, commercial use such as hotel, office, restaurant, or other business or rental use of the product, or service by anyone other than a Factory Servicenter or other Authorized Servicer, or damage that is attributable to acts of God.

**THERE ARE NO EXPRESS WARRANTIES EXCEPT AS LISTED UNDER "LIMITED WARRANTY COVERAGE". THE WARRANTOR IS NOT LIABLE FOR INCIDENTAL OR CONSEQUENTIAL DAMAGES RESULTING FROM THE USE OF THIS PRODUCT, OR ARISING OUT OF ANY BREACH OF THIS WARRANTY.** (As examples, this excludes damages for lost time, cost of having someone remove or re-install an installed unit if applicable, travel to and from the servicer, loss of or damage to media or images, data or other recorded content. The items listed are not exclusive, but are for illustration only.)

**ALL EXPRESS AND IMPLIED WARRANTIES, INCLUDING THE WARRANTY OF MERCHANTABILITY, ARE LIMITED TO THE PERIOD OF THE LIMITED WARRANTY.**

Some states do not allow the exclusion or limitation of incidental or consequential damages, or limitations on how long an implied warranty lasts, so the exclusions may not apply to you.

This warranty gives you specific legal rights and you may also have other rights which vary from state to state. If a problem with this product develops during or after the warranty period, you may contact your dealer or Servicenter. If the problem is not handled to your satisfaction, then write to the warrantor's Consumer Affairs Department at the addresses listed for the warrantor.

**PARTS AND SERVICE, WHICH ARE NOT COVERED BY THIS LIMITED WARRANTY, ARE YOUR RESPONSIBILITY.**

## Customer Services Directory

Obtain Product Information and Operating Assistance; locate your nearest Dealer or Servicenter; purchase Parts and Accessories; or make Customer Service and Literature requests by visiting our Web Site at:

<http://www.panasonic.com/support>

or, contact us via the web at:

<http://www.panasonic.com/contactinfo>

You may also contact us directly at:

1-800-211-PANA (7262),

Monday-Friday 9 am-9 pm; Saturday-Sunday 10 am-7 pm, EST.

For hearing or speech impaired TTY users, TTY : 1-877-833-8855

### Accessory Purchases

Purchase Parts, Accessories and Instruction Books online for all Panasonic Products by visiting our Web Site at:

<http://www.pasc.panasonic.com>

or, send your request by E-mail to:

[npcparts@panasonic.com](mailto:npcparts@panasonic.com)

You may also contact us directly at:

1-800-332-5368 (Phone) 1-800-237-9080 (Fax Only) (Monday - Friday 9 am to 8 pm, EST.)

Panasonic Services Company

20421 84th Avenue South,

Kent, WA 98032

(We Accept Visa, MasterCard, Discover Card, American Express, and Personal Checks)

For hearing or speech impaired TTY users, TTY : 1-866-605-1277

### Service in Puerto Rico

**Matsushita Electric of Puerto Rico, Inc. Panasonic Sales Company**

**Factory Servicenter:**

**Ave. 65 de Infantería, Km. 9.5, San Gabriel Industrial Park,**

**Carolina, Puerto Rico 00985**

**Phone (787)750-4300 Fax (787)768-2910**

# Panasonic®



Omnivision VHS

## Video Cassette Recorder Operating Instructions (Advanced Operations)

For Basic operations, see the separate  
“Basic Operations” instruction book.

### Model No. PV-V464S

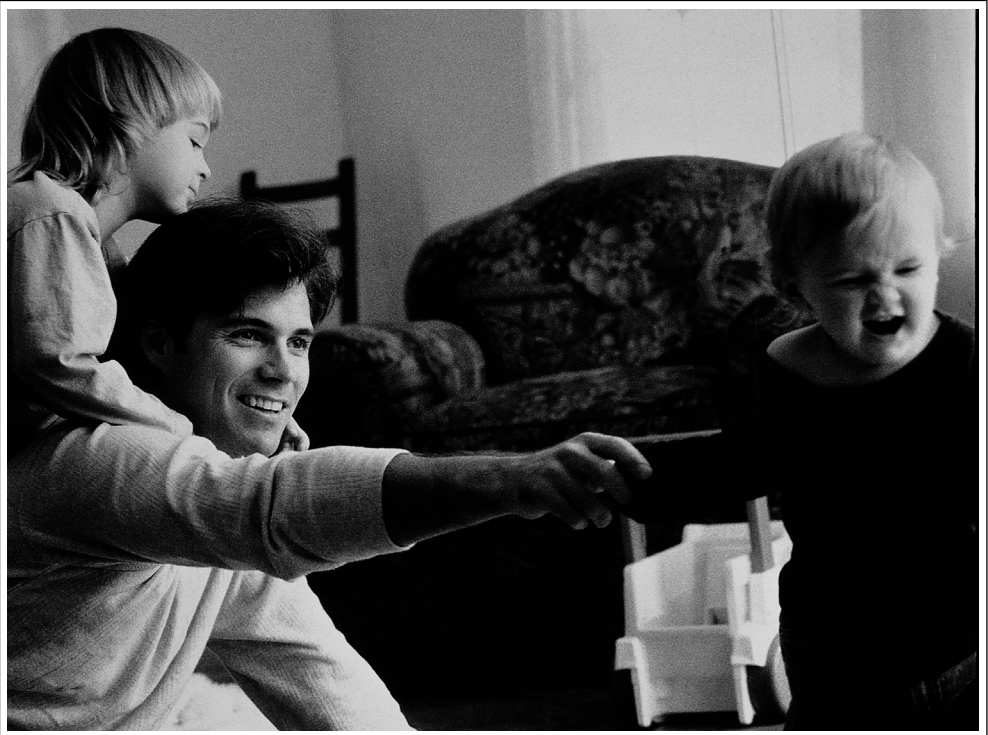

### Table of Contents

Multi-Brand Control Feature .....	2
Advanced Connections (Cable/DSS) .....	3
MTS Broadcast .....	4
VHS Hi-Fi Stereo System .....	5
Tape Operation .....	6, 7
Before Requesting Service .....	8
Copying Your Tapes (Dubbing) .....	9
Special VCR Features .....	10
On-Screen Displays (OSD) .....	11
Reset Language, Channels, Clock, VCR's Output Channel ..	12



As an ENERGY STAR® Partner, Matsushita Electric Corporation of America has determined that this product or product model meets the ENERGY STAR® guidelines for energy efficiency.

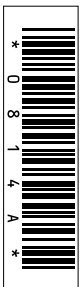

Please read these instructions carefully before attempting to connect, operate or adjust this product. Please save this manual.

LSQT0814 A

# Multi-Brand Control Feature

## Multi-Brand Control Setup

The Remote Control can be set to control some TV functions.

**1 Find your TV Brand Code Number from those shown below.**

**2 Set up for TV control,**

- > hold down **TV** button,
- > enter code with **NUMBER** keys.

**3 Confirm code entry,**

- > **press POWER** to turn your TV on or off.
- See table below for controllable functions in each mode.

### Notes

- Repeat setup after remote battery replacement.
- Remote will not control every TV made by the manufacturer listed. If you get no response, your particular unit cannot be controlled. There are **NO** additional codes for the products listed. If your product is not listed, then the remote is not compatible with that product.

## Using Multi-Brand Control

After remote is set up, you can select VCR or TV for the desired function.

**Press VCR** or **TV** on the remote.

(Table below shows available unit buttons for each mode.)

Unit Mode	VCR	TV
VCR	All	VOL UP/DOWN
TV	VCR/TV, PLAY, STOP, EJECT, SAP/Hi-Fi, DISPLAY, FF, REW, PAUSE/SLOW, REC, SPEED, CM/ZERO, RESET COUNTER, TAPE POSITION	POWER, INPUT, CH UP/DOWN, VOL UP/DOWN

### Notes

- Not all functions listed may be controllable.
- In TV mode, it may be necessary to press ENTER after pressing NUMBER keys for channel selection.

## TV Brand Code Numbers

Panasonic .....	01, 02	Sony .....	08
Quasar .....	01, 02	Toshiba .....	09
RCA .....	03	Sanyo .....	10
GE .....	03	Fisher .....	10
Sharp .....	06	Hitachi .....	12

### Important Notes

- Some manufacturers use several codes for one brand. If the first code entered fails, try the next one listed.
- Some TV brands require you to turn on the power manually.

# Advanced Connections

## Audio/Video connection

If your TV has AUDIO IN and VIDEO IN terminals, you can connect your VCR to them to receive higher quality picture and sound.

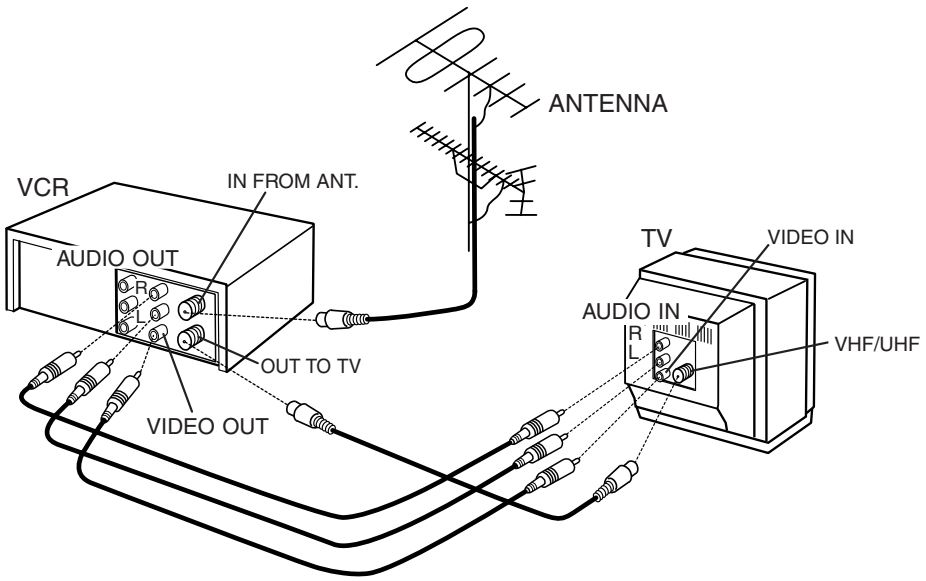

- 1 Connect the VCR's VIDEO OUT jack to the TV's VIDEO IN jack.
- 2 Connect VCR's L/R AUDIO OUT jacks to the TV's L/R AUDIO IN jacks.
- 3 Set the VIDEO/TV selector of your TV (Monitor/Receiver) to "VIDEO."

### With a Cable Box (VCR → Cable Box)

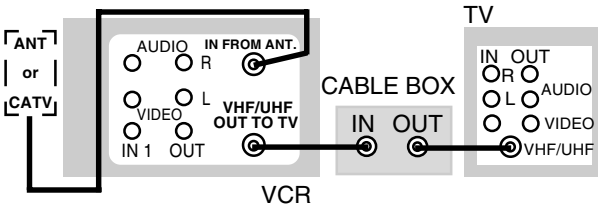

#### You Can

- view any (including scrambled) channel.
- use VCR Remote Control to select channels without using Multi-brand control feature.

#### You Cannot

- record scrambled channels.

### Connect With Two Cable Boxes

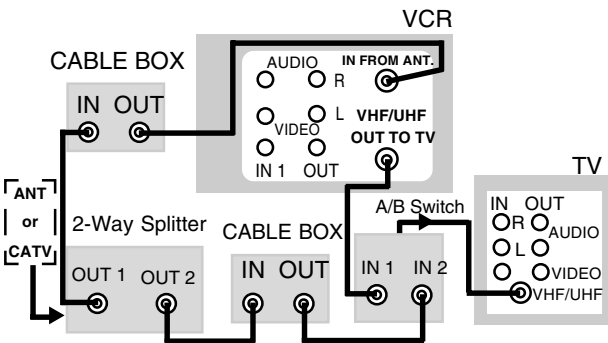

#### You Can

- record and view both scrambled and unscrambled channels if additional equipment is added. This connection requires: two converter boxes, an A/B switch, and a 2-way splitter.

#### You Cannot

- view a channel other than the one selected for any type of recording.
- do a Timer recording of a channel unless you select it at the cable box.

# MTS Broadcast

## Connection

Make the Audio/Video Connection as shown on page 3.

- You can use a TV connected to Stereo amp and speakers instead of a Stereo TV.

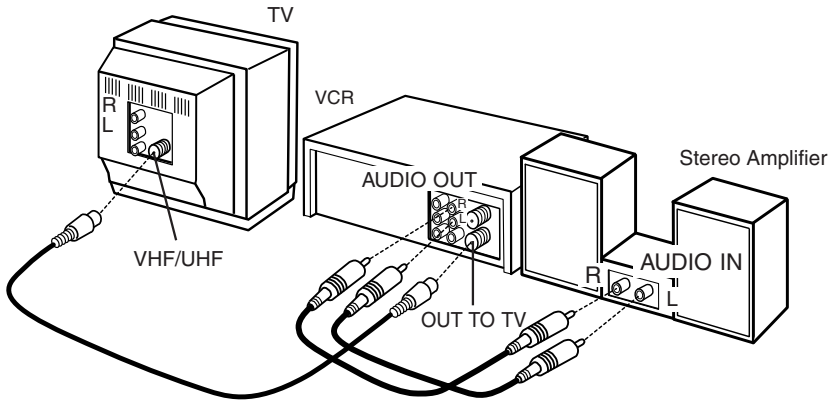

## Receivable Broadcast Types

The following are possible audio broadcast types and on-screen displays.

The signal being received is indicated with a “Ⓒ” mark while the selected audio mode is indicated with an arrow.

To display the broadcast signal being received,

- ➔ **press DISPLAY\***.

### MTS Stereo and SAP broadcast

Multi-channel Television Sound Stereo (main language) and Secondary Audio Program (sub language) broadcasts are being received simultaneously. Select STEREO or SAP audio mode.

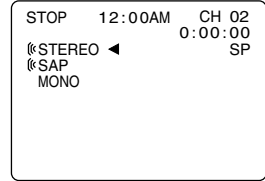

### MTS Stereo broadcast

Multi-channel Television Sound Stereo broadcast. Select STEREO audio mode.

- If stereo broadcast is weak and display flickers, select MONO audio mode for possible better results.

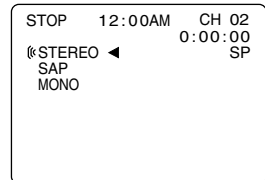

### SAP broadcast

Secondary Audio Program (sub language) broadcast. Select SAP audio mode for the sub language.

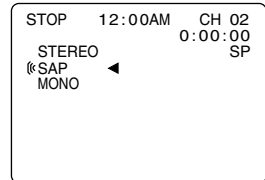

### MONO broadcast

Normal monaural sound broadcast.

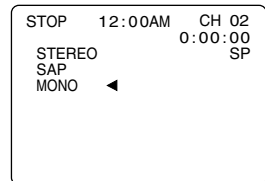

Equipped with **dbx**<sup>®</sup>-TV Noise Reduction for true MTS reproduction. **dbx**<sup>®</sup>-TV Noise Reduction is required for good stereo separation and audio fidelity. **dbx**<sup>®</sup> is a registered trademark, and is licensed by **dbx**<sup>®</sup> Technology Licensing.



# VHS Hi-Fi Stereo System

## Audio Mode for Recording

**1 Press SAP/ Hi-Fi** to display audio mode.  
(Display disappears after 5 seconds.)

**2**  **Press SAP/ Hi-Fi repeatedly** to select desired mode.

- Refer to “Receivable Broadcast Types” on page 4.

- Arrow indicates selection.

**3 Make a recording.**  
See p. 5 of “Basic Operations” Instruction book.

## Audio Mode for Playback

**1 Start playback.**  
See p. 5 of “Basic Operations” Instruction book.

**2 Press SAP/ Hi-Fi** to display audio mode.  
(Display disappears after 5 seconds.)

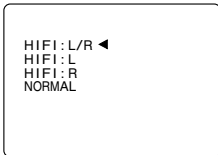
**3**  **Press SAP/ Hi-Fi repeatedly** to select desired mode.

- Select “HIFI(L/R)” or “HIFI(L)” or “HIFI(R)” to listen to stereo recordings in stereo sound. Select “NORMAL” for monaural sound.

- Arrow indicates selection.

### Notes

- Only tapes recorded in Hi-Fi stereo will playback with true stereo sound. Standard stereo tapes will playback in monaural sound.
- To listen to Hi-Fi stereo playback, the VCR AUDIO (L/R) jacks must be connected to a stereo TV or an external stereo amp and speakers. (See page 4.)
- If tracking is adjusted during playback, Hi-Fi audio may revert to normal audio.
- Hi-Fi and normal audio playback volume level may differ.

**\*Important:** If a remote control button does not work when pressed, press the VCR button on the remote and try the button again.

# Tape Operation

## Search System

For each recording, an invisible index mark is placed on the tape.

A program index and information are also included for timer recordings.

These marks are used to access or scan recordings.

### Index Search

1

```

INDEX SEARCH
ENTER INDEX NUMBER :1
USING 1-9 KEYS

FORWARD SEARCH :FF
REVERSE SEARCH :REW

EXIT :SEARCH

```

Press **SEARCH\*** to display **SEARCH** in Stop or Play mode, and then press **NUMBER** keys to select recording number.

- To calculate number, see below.

Press **FF** or **REW** to start search.

2

```

INDEX SEARCH

FORWARD SEARCH :FF
REVERSE SEARCH :REW

```

Play begins at search end. To search forward or back 1 index, press **FF** or **REW** while screen left is displayed (10 sec.).

- To cancel, press **PLAY** or **STOP**.

### To Calculate Index Number

#### Example 1:

To go to rec. 2 from rec. 4, enter 3 and press **REW**.

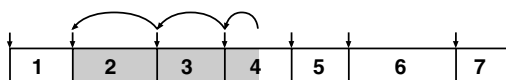

#### Example 2:

To go to rec. 6 from rec. 2, enter 4 and press **FF**.

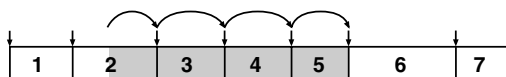

NOTE: ↓ indicates start points of each recording.

#### Note

- If Index Search is started very close to an index mark, that index mark may not be counted in the search.

## Repeat Play

Set to playback a recording over and over.

1 Press **ACTION** to display menu.

2

```

MENU
SET UP VCR
SET UP CLOCK
SET UP CHANNEL
IDIOM/LANGUAGE: ENGLISH
VCR'S OUTPUT CH:3

SELECT :▲▼ SET:▶
EXIT :ACTION

```

Press **▲▼** to select "SET UP VCR," and press **▶**.

3

```

SET UP VCR
REPEAT PLAY : OFF
AUTO SHUT-OFF : OFF
FRONT DISPLAY : ON
AUTO VCR/TV : ON
TAPE SELECT : T-120

SELECT :▲▼ SET:▶
EXIT :ACTION

```

Press **▲▼** to select "REPEAT PLAY," and press **▶** to set "ON" or "OFF."

ON: Play repeats at tape end or if unrecorded portion over 30 sec. is detected.

4

Press **ACTION** to return to normal screen.

## Zero Search

To quickly return to a specified tape location.

1

Press **DISPLAY** during play to display Counter.

2

```

PLAY 12:00AM 0:00:00
SP

```

Press **COUNTER RESET** on remote at desired position to reset to "0:00:00".

3

Continue to record, playback, etc.

4

Press **STOP**.

5

```

REW 12:30AM CH 02
0:30:30
SP

```

Press **CM/ZERO** in Stop mode to start ZERO SEARCH.

- Unit will go into FF or REW mode and stop at the last point the Counter was set to 0:00:00.

```

STOP 12:31AM CH 02
0:00:00
SP

```

# Tape Operation

## Tape Select

Select your tape length so the tape position and amount of tape remaining are properly displayed. (See "Tape Position and Tape Status Display" section below.)

**1 Press ACTION** to display menu.

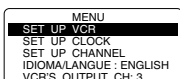
**2**  Press **▲▼** to select "SET UP VCR," and press **▶**.

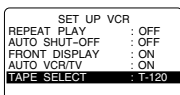
**3**  Press **▲▼** to select "TAPE SELECT," and press **▶** to set "T-120," "T-160" or "T-180."

T-120 → T-160 → T-180

- Select "T-120" for tapes 120 minutes or less, "T-160" if 140 or 160 minutes, and "T-180" if 180 minutes.

**4 Press ACTION** to return to normal screen.

## Commercial Skip

VCR fast forwards (skips) over 1, 2, or 3 minutes of recorded tape as desired.

**1 Press CM/ZERO** in Play mode.

- Press CM/ZERO repeatedly to change skip time as shown below.

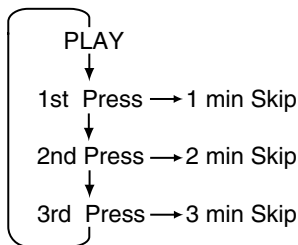

- No indication appears.

## Tape Position and Tape Status Display

To find out the present tape position and amount of tape remaining.

Tape position is displayed incorrectly in the following cases:

- If VHS-C type cassettes, tapes under 30 minutes, tapes over 180 minutes, or incompatible tapes are used.
- If the correct tape length is not selected. (See "Tape Select" section above.)

**1 Press TAPE POSITION**

to detect tape position.

DETECTING TAPE POSITION

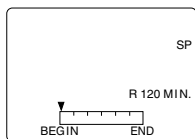

- "DETECTING TAPE POSITION" only appears the first time a cassette is inserted and it takes several seconds for correct indication to appear.
- The present tape position indication and amount of tape remaining (according to tape speed) are displayed. Tape remaining time display may not be precise.

**2 Press TAPE POSITION** (or wait 5 seconds) to return to normal screen.

**\*Important:** If a remote control button does not work when pressed, press the VCR button on the remote and try the button again.

# Before Requesting Service

Check the following points once again if you are having trouble with your VCR.

(BO: refers to "Basic Operations" Instruction book.)

(AO: refers to "Advanced Operations" Instruction book.)

Power	Correction
No power...	<ul style="list-style-type: none"> <li>• Completely insert Power Plug into an AC outlet.</li> <li>• Press POWER button on.</li> <li>• Make sure power source is active.</li> </ul>
Recording & Playback	Correction
TV program cannot be recorded...	<ul style="list-style-type: none"> <li>• Check connections between VCR, external antenna, and TV.</li> <li>• Check connections selection. (BO p. 4, AO p. 3)</li> <li>• Make sure your antenna system (CABLE or TV) is correctly set. (Channels [AO p. 12])</li> <li>• Make sure cassette record tab is intact. (BO p. 3)</li> </ul>
Timer recording cannot be performed...	<ul style="list-style-type: none"> <li>• Confirm that clock is set to current time and date.</li> <li>• Make sure Cable/DSS box (if used) is left on and tuned to channel to be recorded.</li> <li>• Set recording start/stop times correctly. (BO p. 6)</li> <li>• Make sure VCR POWER button is pressed off. (BO p. 6)</li> <li>• Timer recording may not be performed or continued if a power interruption occurs before or during a Timer Recording, even after power is restored.</li> </ul>
There is no playback picture, or the playback picture is noisy or contains streaks...	<ul style="list-style-type: none"> <li>• Select channel 3 or 4 on TV to match VCR output channel (3 or 4) (BO p. 4) or select LINE.</li> <li>• Set VCR/TV selector to "VCR."</li> <li>• Adjust TRACKING control in either direction. (BO p. 3)</li> <li>• Try Head Cleaning. (BO p. 3)</li> </ul>
Special effects playback picture may contain some vertical jitter when using a TV with an Automatic Vertical Hold Control...	<ul style="list-style-type: none"> <li>• Set TV's Vertical Hold Control to MANUAL, then adjust.</li> </ul>
VCR cannot be controlled...	<ul style="list-style-type: none"> <li>• Make sure VCR power is on.</li> <li>• Check Remote batteries.</li> <li>• Make sure VCR LOCK is set to off. (AO p. 10)</li> <li>• Make sure Timer Record is not in progress.</li> </ul>
Remote Control	Correction
VCR cannot be remote controlled...	<ul style="list-style-type: none"> <li>• Make sure VCR power is on.</li> <li>• Make sure Remote is in VCR mode.</li> <li>• Aim Remote Control directly at remote sensor on VCR. (BO p. 7)</li> <li>• Avoid any object blocking signal path.</li> <li>• Check Remote batteries. (BO p. 3)</li> <li>• Make sure VCR LOCK is set to off. (AO p. 10)</li> <li>• Exposing VCR remote sensor to direct fluorescent or outdoor light may cause signal interference.</li> </ul>
ACTION and PROG buttons do not respond...	<ul style="list-style-type: none"> <li>• Check connections between VCR, external antenna, and TV.</li> <li>• Press VCR button for VCR mode. (AO p. 2)</li> <li>• Check Remote batteries. (BO p. 3)</li> </ul>
Miscellaneous	Correction
Programs cannot be viewed on TV...	<ul style="list-style-type: none"> <li>• Make sure TV power is on.</li> <li>• Make sure TV is tuned to VCR's output channel (3 or 4).</li> <li>• Check connections between VCR, external antenna, and TV.</li> <li>• Set VCR/TV selector to "TV." (BO p. 5, AO p.10)</li> <li>• Make sure proper signal source is selected.</li> </ul>
Video cassette cannot be inserted...	<ul style="list-style-type: none"> <li>• Insert the cassette with window side up; record tab facing you.</li> <li>• Check if a tape is already in the unit.</li> </ul>
Video cassette cannot be removed...	<ul style="list-style-type: none"> <li>• Confirm Power Plug is fully inserted into an AC outlet.</li> </ul>
Video cassette ejects when a recording is started or the power is turned off for timer recording...	<ul style="list-style-type: none"> <li>• Make sure cassette record tab is intact. (BO p. 3)</li> </ul>
In Stop mode, the motor (CYLINDER) continues to rotate...	<ul style="list-style-type: none"> <li>• To enable Quick play mechanism, the cylinder will rotate for about 5 minutes. This reduces response time from Stop to Play mode and from Play to Rewind Search mode.</li> </ul>

**If you cannot resolve the problem, please call the Customer Call Center for product assistance at 1-800-211-PANA (7262).**

**To locate an authorized servicer, please call toll free 1-800-211-PANA (7262).**

**or, contact us via the web at: <http://www.panasonic.com/contactinfo>**

**Panasonic Consumer Electronics Company,  
Division of Matsushita Electric Corporation of America**  
One Panasonic Way Secaucus, New Jersey 07094

**Panasonic Sales Company ("PSC"),  
Division of Matsushita Electric of Puerto Rico, Inc.**  
Ave. 65 de Infantería. Km. 9.5 San Gabriel Industrial Park,  
Carolina, Puerto Rico 00985



Printed in Indonesia  
LSQT0814 A  
S1203-1014

# Copying Your Tapes (Dubbing)

## Connection

(Rear connection shown.)

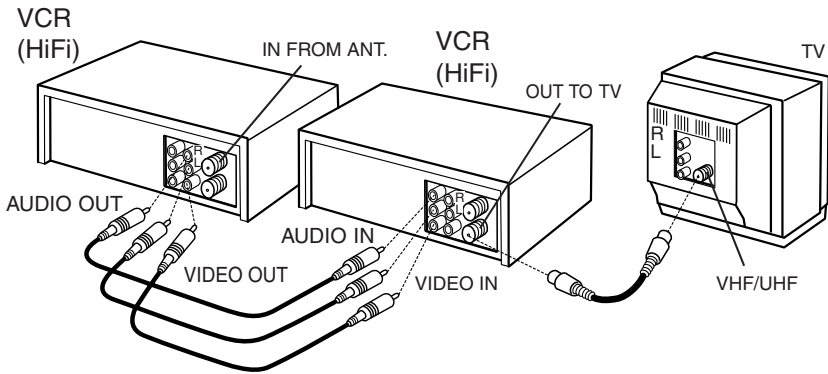

Front of VCR

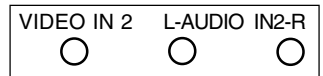

(Front Audio L/R Video IN jacks are also provided)

- ① Connect VIDEO OUT jack on Playing VCR to VIDEO IN jack on Recording VCR. To monitor the dubbing, also connect a TV as shown.
- ② Connect AUDIO L/R OUT jacks on Playing VCR to AUDIO L/R IN jacks on Recording VCR.

In place of a Playing VCR, you can use other equipment, such as a Camcorder. Simply connect the unit's Audio/Video outputs to the Recording VCR.

## Playing (Source) VCR

## Recording (Editing) VCR

- |  |   |
|--|---|
| <p><b>1</b> Insert pre-recorded tape.</p>  | <p>Insert blank tape with record tab.</p>   |
| <p><b>2</b> _____</p>  | <p><b>Press INPUT*</b> to set VCR Input mode to LINE1 for Video Input (Rear) or to LINE2 for Video Input (Front). (See "Selecting the Input Mode" below.)</p> |
| <p><b>3</b> Press <b>PLAY</b>, then <b>PAUSE/SLOW</b> immediately to enter <b>PLAY/PAUSE</b> mode.</p>         | <p><b>Press REC</b>, then <b>PAUSE/SLOW</b> immediately to enter <b>REC/PAUSE</b> mode.</p>   |
| <p><b>The operation of steps 4 and 5 must be done on both playing and recording VCRs at the same time.</b></p> |   |
| <p><b>4</b> Press <b>PLAY</b> to start dubbing. Playing VCR starts playback.</p>                               | <p><b>Press PAUSE/SLOW</b> to start dubbing. Recording VCR starts recording.</p>  |
| <p><b>5</b> Press <b>STOP</b> to stop dubbing.</p>   | <p><b>Press STOP</b> to stop dubbing.</p>   |

### ■ To Monitor Dubbing on Your TV

- 1 Turn your TV on and tune to the Recording VCR channel (CH3 or CH4).
- 2 Set the VCR/ TV Selector on the Recording VCR to "VCR."

### ■ Selecting the Input Mode

- Method 1:**  
**Press INPUT** repeatedly.  
 Channel Number ↔ LINE1 ↔ LINE2
- Method 2:**  
**Press CH ▲ / ▼.**  
 Display will change as below.

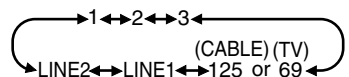

- "L1" or "L2" lights on Multi-Function Display (about 4 sec.) when LINE1 or LINE2 is selected.
- LINE1: For rear audio/video connection.  
 LINE2: For front audio/video connection.

**Note** • Dubbing tapes protected with Copy Guard will have poor quality results.

**Caution:** Unauthorized exchanging and/or copying of copyrighted recordings may be copyright infringement.

**\*Important:** If a remote control button does not work when pressed, press the VCR button on the remote and try the button again.

# Special VCR Features

• Special VCR Features • Copy Your Tapes (Dubbing) • Before Requesting Service

## Auto Shut-Off Feature

The power shuts off at a preset time.

**1** Press **ACTION** to display MENU.

**2** Press **▲▼** to select "SET UP VCR," and press **▶**.

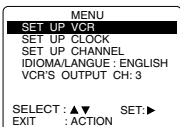

**3** Press **▲▼** to select "AUTO SHUT-OFF." Press **▶** repeatedly to change shutoff time as shown below.

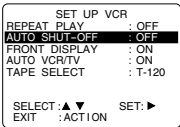

OFF → 2 Hours → 4 Hours → 6 Hours

**4** Press **ACTION** to return to normal screen.

**Note** • The shut-off countdown will not function during Play or Record.

## VCR/TV Selection Feature

The VCR/TV selection can be set to auto or manual.

**1** Press **ACTION** to display MENU.

**2** Press **▲▼** to select "SET UP VCR," and press **▶**.

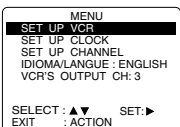

**3** Press **▲▼** to select "AUTO VCR/TV," and press **▶** to set "ON" or "OFF."

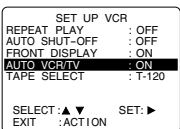

- OFF(Manual): You select "VCR" or "TV" mode using the VCR/TV button on the unit or remote.
- ON(Auto): "VCR" mode is automatically set when VCR is turned on, or in Play mode.

**4** Press **ACTION** to return to normal screen.

**Note** • For more on VCR/TV selection, see "Record one station, watch another" and "Select channels on VCR" sections (p. 5 of Basic Operations book).

## VCR Lock Feature

When set to ON, all operations except for timer record and tape eject are prohibited. Useful for households with small children.

**To turn on**, hold down REC on the VCR in Stop mode with no tape inserted for 7 sec. (Please ignore the NO CASSETTE warning.)

**To turn off**, repeat above.

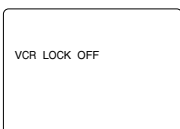
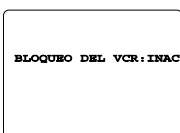

- VCR Lock cancels in 24 hours.

## Weak Signal Display ON/OFF Feature

When set to "ON," picture is displayed regardless of signal strength.

**1** Press **ACTION** to display MENU.

**2** Press **▲▼** to select "SET UP CHANNEL," and press **▶**.

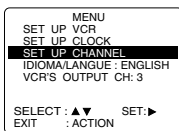

**3** Press **▲▼** to select WEAK SIGNAL DISPLAY, and press **▶** to set "ON" or "OFF."

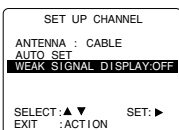

- ON: Picture is displayed even if signal is very weak but quality may be poor.
- OFF: Screen turns solid blue when signal is weak or non-existent.
- Selecting "ON" has no effect on connected equipment with blue back feature.

**4** Press **ACTION** to return to normal screen.

## Multi Function Display (Front Display) ON/OFF Feature

Multi Function Display (Front Display) can be set to ON/OFF.

**1** Press **ACTION** to display MENU.

**2** Press **▲▼** to select "SET UP VCR," and press **▶**.

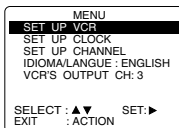

**3** Press **▲▼** to select "FRONT DISPLAY," and press **▶** to set "ON" or "OFF."

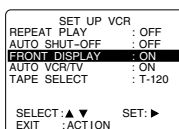

- ON: When set to "ON," Multi Function Display is displayed in Standby (OFF) mode.
- OFF: When set to "OFF," Multi Function Display is not displayed in Standby (OFF) mode. If a Timer Program is set, Multi Function Display is displayed.

**4** Press **ACTION** to return to normal screen.



REC  
Multi Function Display (Front Display)

# On-Screen Displays (OSD)

## On-Screen Displays (OSD)

### Function & Channel Displays



When a function button is pressed, e.g. PLAY, or you change channels, a 5 second display appears.

### Blank Tape/ No Video Signal Indications

When blank tape is detected during play, or the current channel has no signal (with Weak Signal Display feature (p. 10) set to OFF), the TV screen will turn solid blue.

### VCR Status & Clock Displays

To display or remove overlay at right, → press DISPLAY\*.

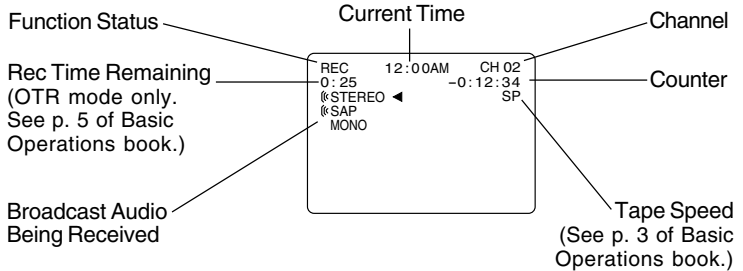

## Warning and Instruction Displays

These displays will alert you to a missed operation or provide further instructions.

OSD	Caution	Page
PLEASE SET CLOCK BY PRESSING ACTION KEY	If you attempt to set or review a Timer Recording and the Clock is not set...	See page 6 of Basic Operations book
TURN VCR OFF FOR TIMER RECORDING	After a Timer Program has been set...	See page 6 of Basic Operations book
CHECK CASSETTE RECORD TAB	If you press REC on the remote control or VCR, and a cassette is inserted with no record tab...	See page 3 of Basic Operations book
NO CASSETTE	If you press PLAY, FF, REW, or REC on the remote control or VCR without a cassette inserted...	See page 5 of Basic Operations book
TO CANCEL TIMER REC PRESS POWER THEN STOP KEY	If you press POWER or STOP during a Timer Recording... (visible in VCR mode only)	See page 6 of Basic Operations book
VIDEO HEADS MAY NEED CLEANING PLEASE INSERT HEAD CLEANING CASSETTE OR REFER TO MANUAL	If head cleaning becomes necessary while playing back a tape...	See page 3 of Basic Operations book
END :PLAY		
VCR LOCK ACTIVATED	If you press a function button other than STOP/EJECT or POWER while the VCR is in VCR Lock mode...	See page 10

**\*Important:** If a remote control button does not work when pressed, press the VCR button on the remote and try the button again.

# Reset Language, Channels, Clock, VCR's Output Channel

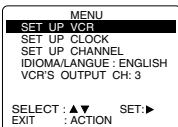

Press **ACTION** to display MENU.

## Language

- 1) Press **▲▼** to select language item.

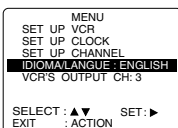

- 2) Press **►** repeatedly to change language item as shown below.

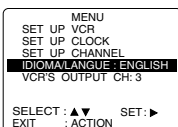

For English

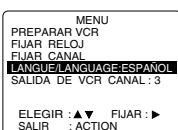

For Spanish

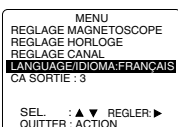

For French

- 3) Press **ACTION** to exit.

## Channels

- 1) Press **▲▼** to select "SET UP CHANNEL," and press **►**.

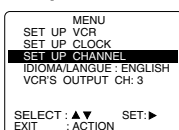

- 2) Press **▲▼** to select "ANTENNA," then press **►** to set your antenna system ("TV" or "CABLE.")

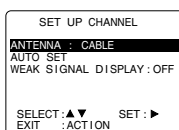

- 3) Press **▲▼** to select "AUTO SET," then press **►**.

- If you use Cable Box, set it to the PBS channel in your time zone.

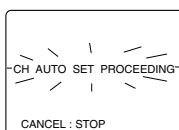

- After Channel Auto Set is finished, Auto Clock Set will be performed.

## Clock

- 1) Press **▲▼** to select "SET CLOCK," and press **►**.

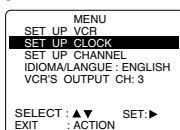

- 2) Press **▲▼** to select "MANUAL," and press **►**. (For Auto Clock Set, select "AUTO CLOCK SET.")

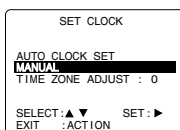

- ("TIME ZONE ADJUST" appears only when auto clock is set.)

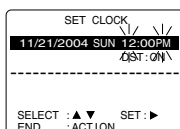

- 3) Press **▲▼** and **◀▶** to select and set the date, time, and DST (Daylight Saving Time).

- 4) Press **ACTION** to start the Clock and exit this mode.

## Time Zone Adjust

(Only when Auto Clock is set.)

- 1) Press **▲▼** to select "SET CLOCK," and press **►**.

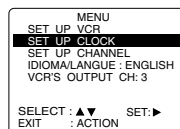

- 2) Press **▲▼** to select "TIME ZONE ADJUST,"

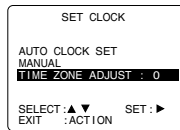

and press **►** to subtract or add hour(s) as necessary.

- 3) Press **ACTION**.

- "TIME ZONE ADJUST" returns to "0" if clock is set manually.

## VCR's Output Channel

- 1) Press **▲▼** to select "VCR'S OUTPUT CH."

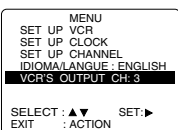

- 2) Press **►**.

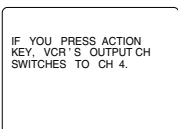

- 3) Press **ACTION**.

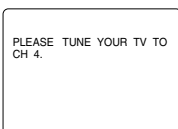

↓ After 3 seconds

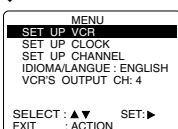

- To Make Corrections, repeat steps 1) ~ 3).

## Add or Delete a Channel

To add channel:  
Select channel with **NUMBER** keys and press **ADD/DLT**.

CHANNEL 08 ADDED

To delete channel:  
Select channel with **CH ▲▼** or **NUMBER** keys and press **ADD/DLT**.

CHANNEL 08 DELETED

## DST (Daylight Saving Time)

VCR auto adjusts clock for DST.

**Spring (First Sunday in April)**

DST:ON → Sets clock ahead one hour.

**Autumn (Last Sunday in October)**

DST:ON → Turns clock back one hour.

- If your area does not observe Daylight Saving Time, select DST:OFF.

- Keep these time changes in mind when programming VCR for timer recordings.